

Powers™ Controls

Free Energy Band™ TH 193 HC Hesitation Room Thermostat

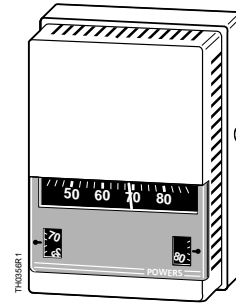

Description

The TH 193 HC Hesitation Thermostats are proportional single output, dual set point, two-pipe (high air capacity) sensor controllers. Each thermostat includes a wall mounting plate for installation in a variety of rough-in terminal boxes. Sensitive bimetals respond to temperature changes to modulate control air through a flapper nozzle. As the heating load decreases due to internal heat gains, a dead band of control minimizes energy consumption while the set point changes from 72°F (22°C) heating mode to 78°F (26°C) cooling mode. Two set point dials allow adjustment of the dead band (4°F, 2°C, minimum). Air connections are made with 5/32-inch (4 mm) O.D. plastic tubing, directly to the thermostat chassis for retrofit applications or with plug-in adapters (provided with the TH 192 rough-in terminal box or optional accessories), which slide into the wall mounting plate.

Features

- Direct and reverse acting
- Two separate adjustable temperature set point indicating dials
- Two highly sensitive bimetal thermostatic elements
- Fahrenheit or Celsius models
- Field adjustable dead band output pressure
- Individual field adjustable sensitivity with graduated scale
- Integral field adjustable limit stops
- Control pressure test port accessible without removing cover
- Easily replaceable thermometer, set point dials, filters and restrictor plate
- Covers available for concealed or exposed thermometers and for either concealed, key, or exposed knob adjustment and set point indication
- Standard plastic thermostat covers provide desert beige or white finish

Optional Design Features

- Fixed temperature limit stops meet government specifications
- Metal covers available in standard configurations with a variety of finishes
- Competitor adapter mounting kits available
- All thermostat chassis available with optional 1/2-inch set point adjustment knobs

Application

TH 193 HC Hesitation Thermostats control valve and damper actuators in building applications that require early morning heat and afternoon cooling. TH 193 HC Hesitation Thermostats control space temperature and take advantage of the dead band to "float" room temperature between heating and cooling modes while maintaining energy management (maximum economy) and occupancy comfort.

Use TH 193 HC Hesitation two-pipe thermostats where multiple valves and actuators, used with or without high/low limiting controls, require higher air capacities. The thermostats are available with covers that conceal or expose the set point adjustment dials.

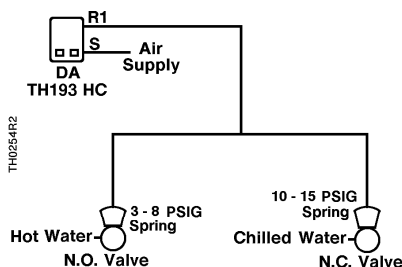

Figure 1. Typical TH 193 HC Hesitation Thermostat Application.

Piping

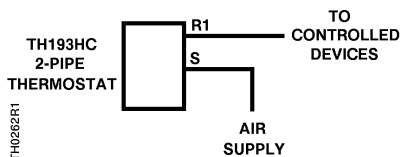

Figure 2. TH 193 HC Hesitation Thermostat Connections.

Product Numbers and Ordering Information

See Table 1 for product number and ordering information on TH 193 HC Hesitation Thermostat chassis.

Chassis

1. Is a Fahrenheit or Celsius scale required?
2. Is the heating and cooling control direct or reverse acting?
3. Where is the set point adjustment knob located?
 - a. Adjustment knob located at bottom of chassis.
 - b. Adjustment knob on front with 1/2-inch exposed knob.

Table 1. TH 193 HC Hesitation Thermostat Chassis Part Numbers.

| Chassis with Wall Plate | | | | | |
|-------------------------|------------------------------|------------------------|------------------------|------------------------|------------------------|
| Connection Type | Set Point Adjustment | Fahrenheit | | Celsius | |
| | | Heating and Cooling DA | Heating and Cooling RA | Heating and Cooling DA | Heating and Cooling RA |
| Hesitation | Exposed at Bottom of Cover | 193-219 | 193-220 | 193-239 | 193-240 |
| | Exposed 1/2" Knob on Cover * | 193-219K | 193-220K | 193-239K | 193-240K |

* This feature requires a key set point adjustment cover (or key type cover). See Table 2.

Covers

See Table 2 for product number and ordering information on TH 193 HC Thermostat covers.

1. Is the set point adjustment exposed for customer adjustment or concealed to prevent alteration of setting?
2. Is the thermometer exposed or concealed?
3. Is the set point indication exposed or concealed behind the cover?
4. Is a plastic or zinc cast metal cover required?
 - a. Plastic covers order 192-2XX.
 - b. Metal covers order 192-3XX.
5. Is finish of cover standard or optional?
 - a. Standard cover is plastic, desert beige color. For white plastic cover option, add "W" suffix code to cover part number (e.g., 192-256W).
 - b. Optional covers are plastic or metal and available in a variety of colors. See Table 3.

Table 2. TH 193 HC Hesitation Thermostat Cover Part Numbers.

| Set Point Adjustment | Cover Configuration | | Cover Part Number ² | |
|----------------------|---------------------|---------------------|--------------------------------|----------------------|
| | Thermometer | Set Point Indicator | Standard Plastic Cover | Standard Metal Cover |
| Concealed | Concealed | Concealed | 192-256 | 192-356 |
| | Exposed | | 192-254 | 192-354 |
| Key ¹ | Concealed | Exposed | 192-267 | 192-367 |
| | Exposed | | 192-268 | 192-368 |
| Exposed | Concealed | Exposed | 192-258 | 192-358 |
| | Exposed | | 192-260 | 192-360 |

- 1 Key set point adjustment cover required for all thermostat chassis with optional 1/2-inch set point adjustment knobs.
- 2 To order an optional thermostat cover finish, add the appropriate suffix letter listed in Table 3 to the end of the part number listed in Table 2.

**Table 3. TH 193 HC Hesitation Thermostat
 Suffix Letters for Optional Cover Part Numbers.**

NOTE: For color samples, order Color Reference Guide P/N 152-178P10.

| Part Number Suffix Letter | Cover Material | Cover Finish | Part Number Suffix Letter | Cover Material | Cover Finish |
|---------------------------|--------------------|-----------------------------|---------------------------|------------------|-------------------------------------|
| None | Plastic (standard) | Desert Beige | D | Metal (optional) | No. 10 Special Bronze |
| W | Plastic (optional) | White | E | | Brushed Electro-plated Satin Chrome |
| None | Metal (standard) | Desert Beige | F | | Sierra Gold |
| A | Metal (optional) | No. 1 Silver | G | | Brushed Aluminum |
| B | | No. 5 Satin Chrome | H | | White |
| C | | No. 7 Light Statuary Bronze | | | |

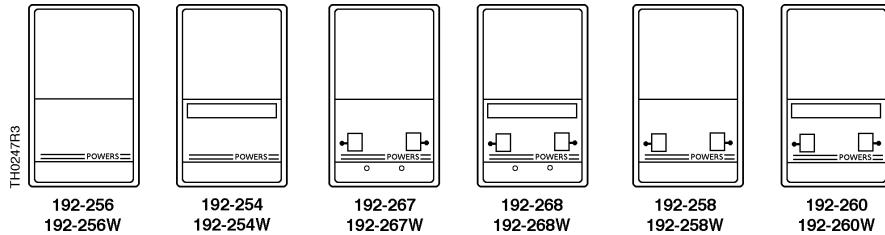

Specifications

| | |
|----------------------------------|---|
| Control action | See Table 1 |
| Operating ranges | 45°F to 85°F (7°C to 30°C) |
| Supply air pressure, maximum | 30 psi (207 kPa) |
| Normal air supply pressure | 18 to 25 psi (124 to 172 kPa) |
| Sensitivity adjustment | 1 to 4 psi/°F (12 to 50 kPa/°C) |
| Nominal air consumption | 40 scim (11 ml/sec) |
| Dead band | |
| Output Pressure Adjustment Range | 1 to 15 psi (7 to 103 kPa) 0°F to 40°F (0°C to 20°C) |
| Temperature | |
| Storage temperature | -10°F to 140°F (-23°C to 60°C) |
| Ambient operating temperature | 40°F to 140°F (4°C to 60°C) |
| Temperature response | 0.1°F (0.06°C) |
| Dial graduations | 2°F (1°C) |
| Factory settings | |
| Calibration | 72°F (22°C) |
| Sensitivity | 2.5 psi/°F (31 kPa/°C) |
| Limit stop adjustment | 45°F and 85°F (7°C and 30°C) |
| Standard cover | Cyclac, desert beige |
| Shipping weight | 0.7 lbs. (0.3 kg) |
| Dimensions | See Figure 9. |

Accessories

See the following Technical Bulletins for information on accessories

| Technical Bulletin | Document Number |
|----------------------|-----------------|
| TB 237 Terminal Kits | 155-244P25 |
| TB 214 Adapter Kits | 155-231P25 |
| TB 193 Guard Kit | 155-222P25 |
| TB 241 Test Head Kit | 155-255P25 |
| TB 167 Restrictors | 155-213 |

**TH 193 HC FEB
 Hesitation
 Thermostat Details**

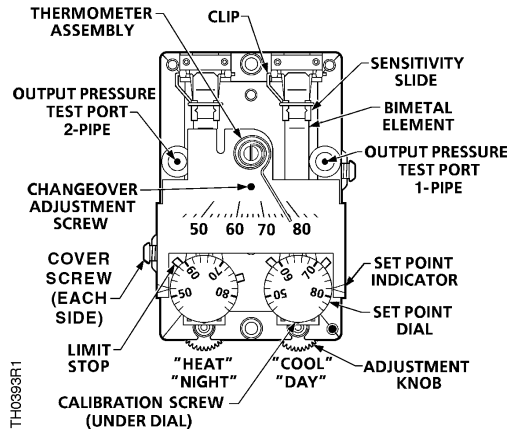

Figure 3. TH 193 HC Hesitation Thermostat Details.

Operation

The TH 193 HC Hesitation Thermostat is a two temperature thermostat with a single output. In direct acting control, an increase in temperature increases the control air pressure and a decrease in temperature decreases the control pressure. In reverse acting control, an increase in temperature decreases the control air pressure and a decrease in temperature increases the control pressure.

The TH 193 HC Hesitation Thermostat provides two separate bimetal elements; one for heating mode and the other for cooling mode. The set point of the two elements determines the window of the dead band. A 4°F (2°C) minimum dead band is standard, where the heating mode set point is 72°F (22°C) and the cooling mode set point is 78°F (26°C). Figure 4 shows a typical application with set points adjusted for a 6°F (4°C) dead band.

Figure 5 shows direct acting TH193 HC hesitation output characteristics. As heating increases, the output pressure increases from 0 to 8 psi (0 to 52 kPa). A field adjustable dead band occurs. The dead band spans from 0°F to 40°F (-17°C to 4°C) with a 3 to 15 psi (21 to 103 kPa) output pressure. When the dead band elapses, cooling increases from 8 to 15 psi (52 to 103 kPa).

Operation,
 Continued

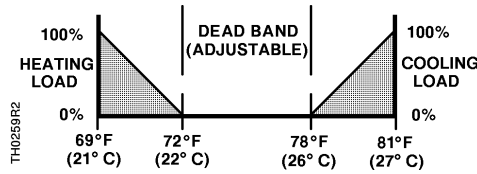

Figure 4. TH 193 HC Hesitation Operating Characteristics.

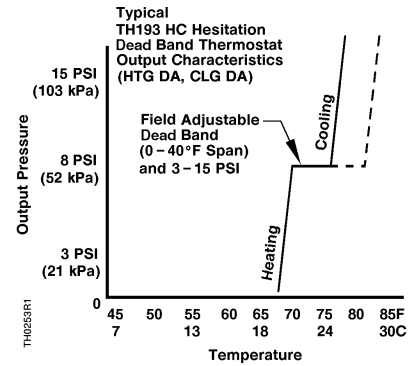

Figure 5. TH 193 HC Hesitation Input/Output Characteristics.

Thermometer
 Calibration

1. Use a test thermometer to read the current room temperature.
2. Place a screwdriver in the center of the thermometer assembly (Figure 3). Carefully rotate thermometer assembly until pointer tip indicates the correct room temperature.

NOTE: Avoid breathing on or touching the bimetal spiral since this influences the temperature reading.

Dead Band Output
 Pressure Adjustment

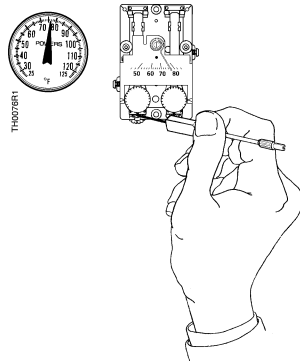

Step 1 —
 Set heating dial to minimum temperature and cooling dial to maximum temperature.

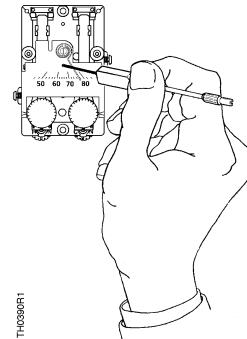

Step 2 —
 Adjust relief valve until control pressure is at dead band output pressure.

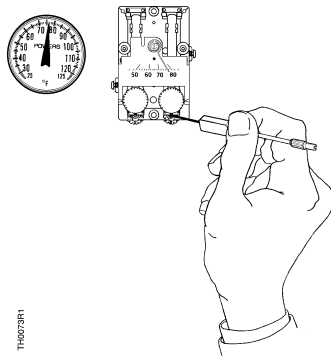

Step 3 —
 Set heating and cooling dials to desired set points. The dead band is between these two set points.

Limit Stop Adjustment

Thermostat limit stops define the minimum and maximum thermostat set points. The limit stops engage in the set point cam gear teeth and cause interference between the set point cam gear and the adjustment knob gear.

To change limit stop settings, use needle nose pliers to pull limit stop between the set point cam gear teeth. Rotate limit stop to its new position. Do not pull limit stop any more than necessary to clear the gear teeth. Changing the limit stop position one gear tooth changes the limit stop setting by 1-1/3°F (0.7°C).

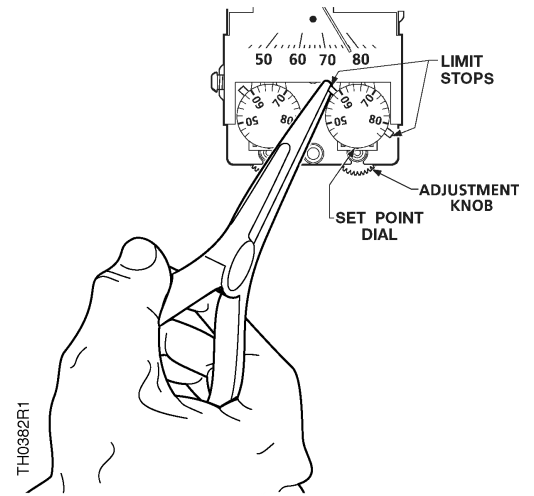

Figure 6. Thermostat Limit Stop Adjustments.

Sensitivity Adjustment

To change thermostat sensitivity, use a flat-blade screwdriver to carefully move the sensitivity slide to the desired position as follows:

Graduation closest to the rigid end of the bimetal element
 4 psi/°F
 (50 kPa/°C)



Graduation closest to the minimum end of the bimetal element
 1 psi/°F
 (12 kPa/°C)

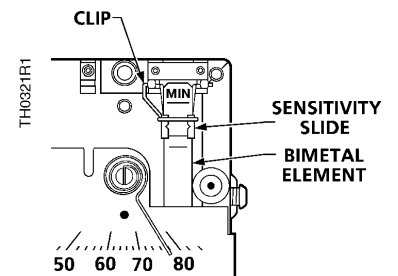

Figure 7. TH 193 HC Hesitation Sensitivity Adjustment.

NOTE: If the thermostat sensitivity is adjusted, the thermostat must be recalibrated.

Thermostat Calibration

The thermostat is factory calibrated to a control pressure of 7.5 psi (52 kPa) when the set point and the ambient temperature are both at 72°F (22°C). The factory sensitivity setting is approximately 2.5 psi/°F (31 kPa/°C). No adjustments are required if these settings are appropriate for the application. If the thermostat has been tampered with, the sensitivity changed, or is out of adjustment, use the following steps to recalibrate the instrument.

Cooling Calibration

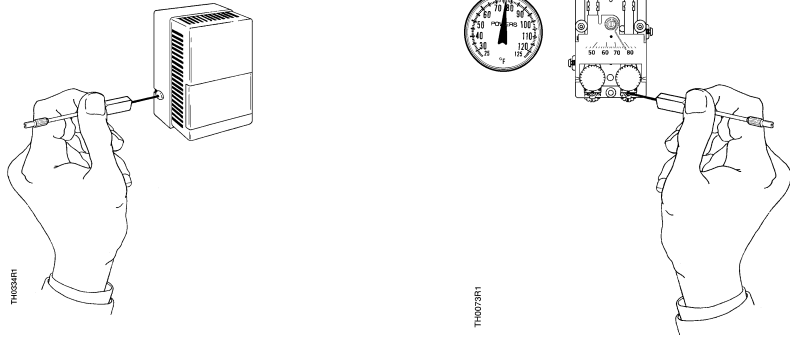

Step 1 —

Remove cover using P/N 192-632 calibration tool. Verify room temperature is between 70°F and 80°F (21°C and 27°C).

Step 2 —

Verify that supply pressure is 18 to 25 psi (124 to 172 kPa). Set cooling dial to room temperature by turning the exposed adjustment knob or using a hex key as shown. Allow thermostat to stand for about five minutes to adjust to the new setting.

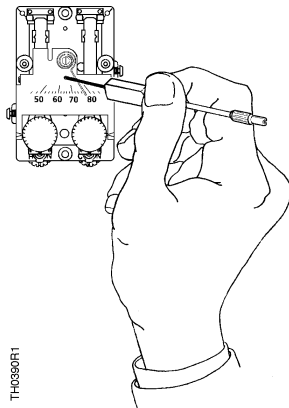

Step 3 —

Rotate adjustment screw clockwise to open relief valve to maximum. Allow thermostat to stand for about five minutes to adjust to the new setting.

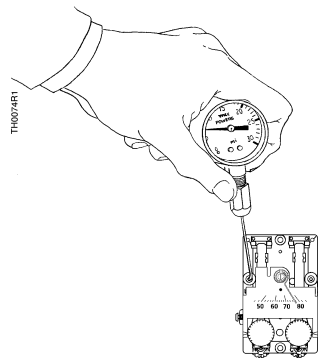

Step 4 —

Moisten needle and insert P/N 192-633 test gauge and needle adapter in the test port. Read control pressure.

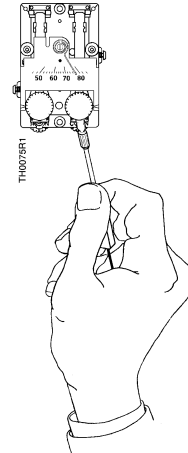

Step 5 —

If control pressure does not read 7 to 8 psi (48 to 55 kPa), turn calibration screw using P/N 192-632 calibration tool or 1/8-inch (3.2 mm) wrench until pressure is 7 to 8 psi (48 to 55 kPa). The sensing element is now in calibration and the set point can be changed to the desired room temperature.

Heating Calibration

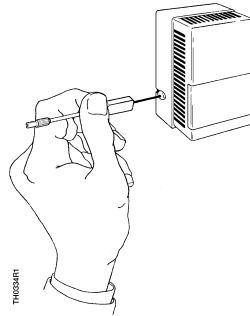

Step 1 —
 If not already done, remove cover using P/N 192-632 calibration tool. Verify room temperature is between 70°F and 80°F (21°C and 27°C).

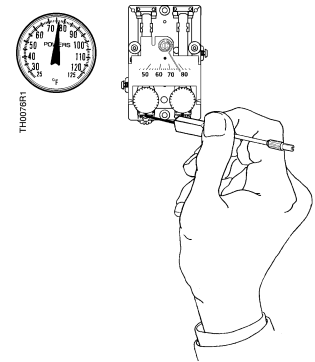

Step 2 —
 Verify that supply pressure is 18 to 25 psi (124 to 172 kPa). Set heating dial to minimum and cooling dial to maximum temperature by turning the exposed adjustment knob or using a hex key as shown.

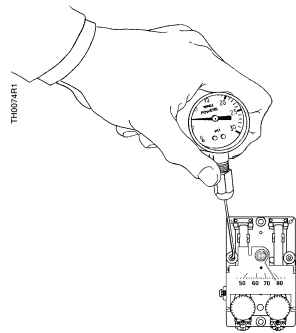

Step 3 —
 Moisten needle and insert P/N 192-633 test gauge and needle adapter in the test port. Read control pressure.

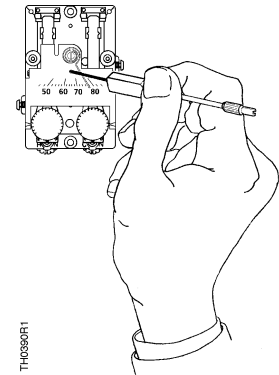

Step 4 —
 Rotate adjustment screw counterclockwise to close relief valve until pressure is at least 5 psi (35 kPa). Allow thermostat to stand for about five minutes to adjust to the new setting.

Heating Calibration, Continued

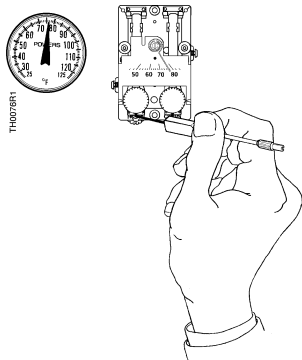

Step 5 —

Set heating dial to room temperature by turning the exposed adjustment knob or using a hex key as shown. Allow thermostat to stand for about five minutes to adjust to the new setting.

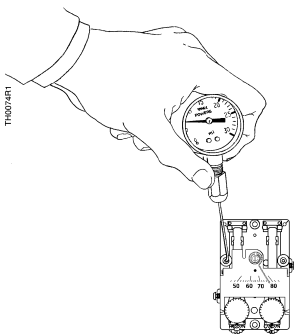

Step 6 —

Moisten needle and insert P/N 192-633 test gauge and needle adapter in the test port. Read control pressure.

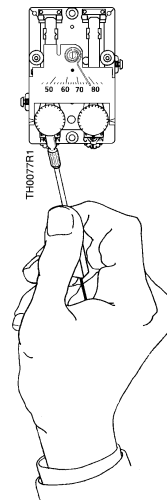

Step 7 —

If control pressure does not show required dead band output pressure, turn calibration screw to obtain this pressure. Sensing element is now in calibration.

Troubleshooting

Before troubleshooting thermostat per Table 4, make certain there is clean, dry supply air at 18 psi (124 kPa) minimum. Use test probe gauge and needle adapter to measure control pressure at thermostat test port.

The output pressure test port is accessible without removing the thermostat cover through the 8th opening from the top left side for two-pipe thermostats.

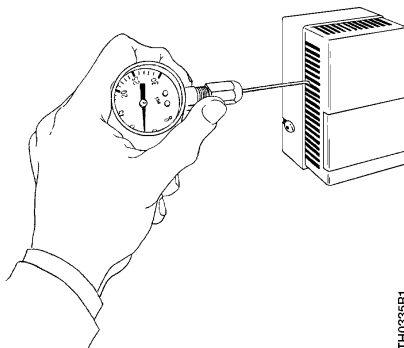

Figure 8. Accessing Output Pressure Test Port.

Table 4. Troubleshooting Guide.

| Problem | Check | Cause | Action |
|--|-----------------------------------|---|--|
| Control pressure stays at approximately zero | Air supply | Low supply pressure | As required |
| | Nozzle or flapper | Dirt on nozzle or flapper | Clean nozzle or replace thermostat |
| | Restrictor | Clogged restrictor | Replace restrictor |
| | Calibration | Out of calibration | Recalibrate |
| Control pressure stays at approximately supply pressure | Nozzle | Clogged nozzle | Clean nozzle or replace thermostat |
| | Calibration | Dirt on either supply or exhaust valve seat | Alternately close and open nozzle by gently pushing down the bimetal |
| Excessive air leakage from exhaust port on left side of thermostat | Supply and return line connection | Connections are interchanged or connection to port is incorrect | As required |

Chassis Tube Connector and Restrictor Plate Replacement



1. Remove thermostat chassis from wall. Terminal does not have a ball check valve.
NOTE: You must close off the supply air. For example, use a connector with the supply air terminal plugged.
2. Remove two Phillips head screws from connector on back of thermostat chassis. Pull connector out of recess. If necessary, pry connector loose with a screwdriver, but be careful not to damage restrictor plate and gasket.
3. Remove gasket from under connector. Remove restrictor. Remove second gasket from under restrictor.
4. Use restrictor replacement kit P/N 192-321 to replace gasket, restrictor, and second gasket.
NOTE: The restrictor plate is keyed to ensure proper orientation during installation.
5. Remove filters from existing connector and insert in new connector. Or, if filters are dirty, use restrictor replacement kit P/N 192-321 to replace filters.
6. Use chassis tube connector replacement kit P/N 192-525 to replace connector and mounting screws.

Service Parts

The following chart lists accessory parts and tools available for thermostat service.

| Description | Part Number |
|---|-------------|
| Dial thermometer (-40°F to 140°F, -40°C to 60°C) with pocket case | 141-0573 |
| Basic pneumatic calibration kit with thermometer, gauge, squeeze bulb, fittings, and case | 832-177 |
| Test head kit | 832-179 |
| Calibration tools | 832-178 |
| Test probe to check pressure with cover on | |
| Needle probe with 1-1/2 inch diameter gauge 0-30 psig (0-200 kPa) and calibration/cover wrench | 192-633 |
| Needle probe, no gauge (package of five) | 192-759 |
| 1-1/2 inch diameter gauge, 0-200 kPa, back connected 1/8-inch NPT male | 142-0344 |
| 1-1/2 inch diameter compound gauge, 0-30 psig/0-200 kPa, back connected 1/8-inch NPT male | 142-0373 |
| 1-1/2" diameter compound gauge, 0-30 psig/0-200 kPa, bottom connected 1/8-inch NPT male. Replacement for use with 192-633 | 142-0426 |
| Chassis tube connector replacement kit with mounting screws (material for 10 thermostats included) | 192-525 |
| Restrictor plate replacement kit with filters and gasket (material for 10 thermostats included) | 192-321 |
| Plug-in adapters for quick thermostat removal | |
| Straight, blue (package of 20) | 192-485 |
| Straight, white (package of 20) | 192-486 |
| Air link connects adapters for pressure tests (package of 20) | 192-501 |
| Compression ring (package of 100) | 141-388 |
| Elbow (provides quick return for wall surface mounting), blue (package of 20) | 192-487 |
| Elbow (provides quick return for wall surface mounting), white (package of 20) | 192-488 |
| 20 scim (5.4 ml/sec) restrictors for one-pipe systems (package of 5). (1/4-inch, 6.4 mm, O.D. plastic barb unless noted.) | |
| Brass coupling, 1/8-inch NPT (1 only). | 184-040 |
| Coupling | 184-116 |
| Tee | 184-113 |
| Pre-piped dual tee for dual one-pipe systems | 184-130 |

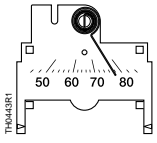
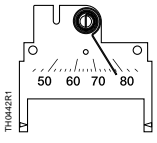
**Service Parts,
 Continued**

| Description | | Part Number |
|---|--|--|
| Replacement thermometer kits, brown (packages of 5) | | 192-775 |
| Scale Range | Thermostat Model | |
| 45°F to 85°F |  Model 3 and Up | |
| 10°C to 30°C | | |
| 45°F to 85°F |  Models 1 and 2 | |
| 10°C to 30°C | | |
| Replacement set point dials (packages of 10) | |  |
| °F, Direct Acting | Right Side | |
| °F, Reverse Acting | | |
| °C, Direct Acting | | |
| °C, Reverse Acting | | |
| °F, Direct Acting | Left Side | |
| °F, Reverse Acting | | |
| °C, Direct Acting | | |
| °C, Reverse Acting | | |

Dimensions

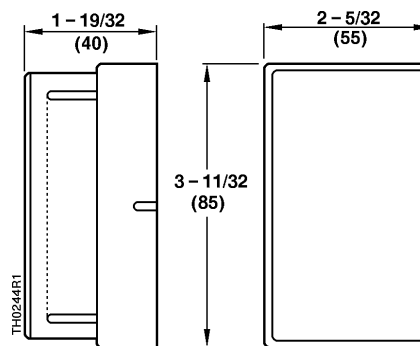

Figure 9. TH 193 HC Hesitation Room Thermostat Dimensions in Inches (Millimeters).

Information in this publication is based on current specifications. The company reserves the right to make changes in specifications and models as design improvements are introduced. **Free Energy Band** is a trademark of Siemens Building Technologies, Inc. Other product or company names mentioned herein may be the trademarks of their respective owners. © 2001 Siemens Building Technologies, Inc.